

EX PRESSURE TRANSMITTER

Die Schweizer Trafag AG ist ein führender, internationaler Hersteller von qualitativ hochwertigen Sensoren und Überwachungsgeräten zur Messung von Druck und Temperatur.



Anwendungen

- Ex Zone 0, 1, 2 / Gas
- Ex Zone 20, 21, 22 / Staub
- Ex Untertagebau (Mining)
- Schiffbau

Vorteile

- Ex SEV 11 ATEX 0145 X
- Druckbereiche ab 100 mbar
- Varianten mit vorneuliegender oder mit frontbündiger Membran
- Medientemperaturen bis 150°C
- Optionaler Blitzschutz (IEC 61000-4-5), 10kA (8/20 µs)

03/2021

Datenblatt H722271

Technische Daten

Messprinzip	Piezoresistiv	Umgebungstemperatur	T3/T4: -25°C ... +85°C T6: -25°C ... +55°C
Messbereich	0 ... 0.1 bis 0 ... 1000 bar	Zulassung / Konformität	DNV-GL
Ausgangssignal	4 ... 20 mA	Zündschutzart	 II 1G Ex ia IIC T3 ... T6 Ga II 1D Ex ia IIIC T125°C Da I M1 Ex ia I Ma
Medientemperatur	T3: -25°C ... +150°C T4: -25°C ... +100°C T6: -25°C ... +55°C		

Änderungen vorbehalten

Bestellinformation/Typencode

		XXXX	XX	XX	XX	XX	XX	XX	
Varianten Code	Relativdruck	8852							
	Absolutdruck	8853							
Messbereich ¹⁾	Druckmessbereich [bar]	Überdruck [bar]	Berst- druck [bar]		Druckmessbereich [bar]	Überdruck [bar]	Berst- druck [bar]		
	0 ... 0.1	3	200	66	0 ... 16	48	200	79	
	0 ... 0.16	3	200	67	0 ... 25	75	200	80	
	0 ... 0.2	3	200	68	0 ... 40	120	850	81	
	0 ... 0.4	3	200	69	0 ... 60	180	850	82	
	0 ... 0.6	3	200	70	0 ... 100	300	850	83	
	0 ... 1	3	200	71	0 ... 160	480	850	85	
	0 ... 1.6	4.8	200	73	0 ... 250	750	850	74	
	0 ... 2.5	7.5	200	75	0 ... 400	850	850	84	
	0 ... 4	12	200	76	0 ... 600	850	850	86	
	0 ... 6	18	200	77	0 ... 1000	1500	1500	88	
	0 ... 10	30	200	78					
	Sensor	Typ 05 (Genauigkeit NLH: ± 0.5 % d.S.) ²⁾							P5
		Typ 02 (Genauigkeit NLH: ± 0.25 % d.S.) ²⁾							P2
Typ 01 (Genauigkeit NLH: ± 0.1 % d.S.) ²⁾								P1	
Druckanschluss	G1/4" innen							10	
	G1/4" aussen							15	
	G1/4" aussen (Manometer)							20	
	G1/2" aussen							21	
	G1/2" aussen, vorliegende Membran							31	
	G1/2" aussen, frontbündige Membran							32	
	G1/2" aussen (Manometer)							11	
Elektrischer Anschluss	Gerätestecker: MIL-C 26482 (Mat.: Al), IP 40							02	
	Gerätestecker: DIN43650-A, Mat.: PA, IP65							04	
	Gerätestecker: Binder 723, Mat.: Zn, IP67							14	
	Gerätestecker M12x1, 4-polig, Metall							32	
	Kabel PUR: Länge ... (mm) IP67							22	
	Kabel FEP: Länge ... mm (IP67)							39	
Ausgangssignal	4 ... 20 mA							19	
	4 ... 20 mA mit Blitzschutz (Surge)							09	
Zubehör	Kabeldose EN 175301-803-A (DIN43650-A)							58	
	Kabeldose: Binder 723							37	
	Kabeldose: MIL-C 26482, 6-polig, Metall, Zone 0,1,2 (Ga)							32	
	Spezial Ölfüllung: Anderol							94	
	Temperaturklasse T3							T3	
	Temperaturklasse T4							T4	
	Temperaturklasse T6							T6	
	Titan (Druckanschluss- und Gehäusematerial)							Ti	

¹⁾ Sonderdruckbereiche nach Kundenwunsch auf Anfrage

²⁾ Genauigkeit NLH siehe Tabelle



Baugleiche Modelle mit anderen Spezifikationen:
Datenblatt No. H72230

Spezifikationen		
Elektrische Daten	Ausgangssignal / Speisespannung	4 ... 20 mA / 10 ... 30 VDC
	Bürde	$R_L \leq (U_S - 9V) / 20 \text{ mA}$
	Anstiegszeit	Typ. 1 ms / 10 ... 90 % Nenndruck
Umgebungsbedingungen	Medientemperatur	T3: -25°C ... +150°C T4: -25°C ... +100°C T6: -25°C ... +55°C
	Umgebungstemperatur	T3/T4: -25°C ... +85°C T6: -25°C ... +55°C
	Schutzart ¹⁾	Min. IP65
	Feuchtigkeit	Max. 95 % relativ
	Vibration	6 g (25...2000 Hz)
	Schock	50 g / 1 ms
EMV-Schutz	Emission	EN/IEC 61000-6-3
	Immunity	EN/IEC 61000-6-2
Mechanische Daten	Sensor (medienberührend)	1.4435 (AISI316L)
	Druckanschluss (medienberührend)	1.4435 (AISI316L)
	Gehäuse	1.4435 (AISI316L)
	Dichtung	FKM 70 Sh (Viton)
	Gerätestecker	Siehe Bestellinformation
	Gewicht	~ 220 g
	Anziehdrehmoment	25 Nm

¹⁾ Nur mit vorschriftsmässig montierter Kabeldose gültig

Genauigkeit						
Druckmessbereich	[bar]	0.1 ... 0.5	0.5 ... 2	2 ... 25	25 ... 600	> 600
Genauigkeit NLH (BSL durch 0) P5	[± % d.S.]	± 0.5	± 0.5	± 0.5	± 0.5	± 0.5
Genauigkeit NLH (BSL durch 0) P2	[± % d.S.]	± 0.25	± 0.25	± 0.25	± 0.25	± 0.25
Genauigkeit NLH (BSL durch 0) P1	[± % d.S.]	-	± 0.1	± 0.1	± 0.1	-
Temperaturkoeffizient Nullpunkt 0 ... +70°C	[± % d.S./K]	± 0.06	± 0.03	± 0.015	± 0.015	± 0.015
Temperaturkoeffizient Nullpunkt Option -25 ... +85°C	[± % d.S./K]	± 0.08	± 0.04	± 0.02	± 0.02	± 0.02
Temperaturkoeffizient Spanne 0 ... +70°C	[± % d.S./K]	± 0.015	± 0.015	± 0.015	± 0.015	± 0.015
Temperaturkoeffizient Spanne Option -25 ... +85°C	[± % d.S./K]	± 0.02	± 0.02	± 0.02	± 0.02	± 0.02
Langzeitdrift	[1 Jahr]	< 4 mbar	< 4 mbar	< 0.2 % d.S.	< 0.2 % d.S.	< 0.2 % d.S.
Reproduzierbarkeit	[± % d.S.]	± 0.05	± 0.05	± 0.05	± 0.05	± 0.05

Dimensionen

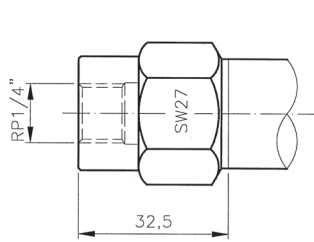

885X.XX.XX10.XX.XX.XX

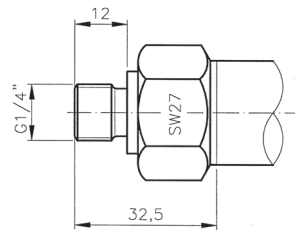

885X.XX.XX15.XX.XX.XX

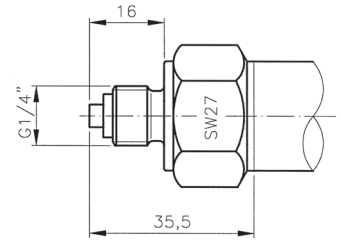

885X.XX.XX20.XX.XX.XX

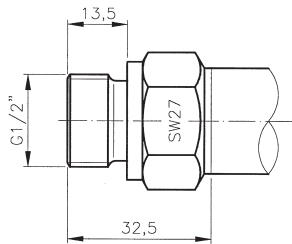

885X.XX.XX21.XX.XX.XX

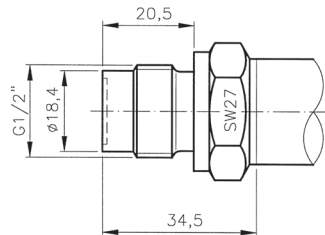

885X.XX.XX31.XX.XX.XX

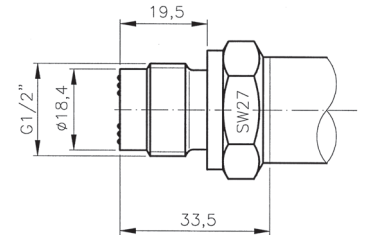

885X.XX.XX32.XX.XX.XX

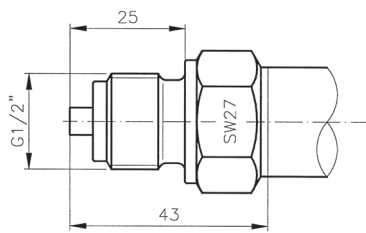

885X.XX.XX11.XX.XX.XX

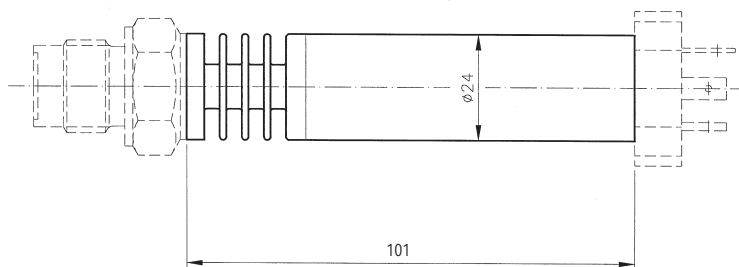

885X.XX.XXXX.XX.XX.T3

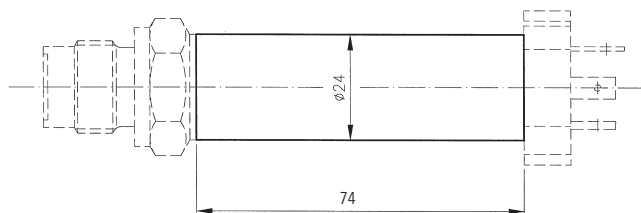

885X.XX.XXXX.XX.XX.T4

885X.XX.XXXX.XX.XX.T6

Dimensionen

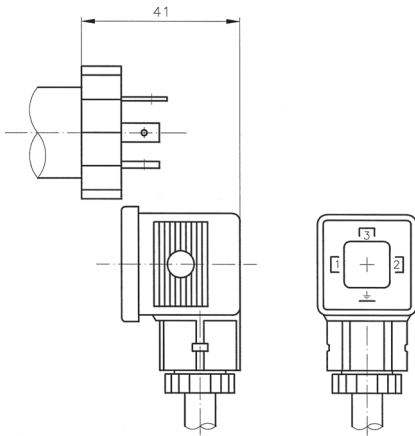

885X.XX.XXXX.04.XX.58

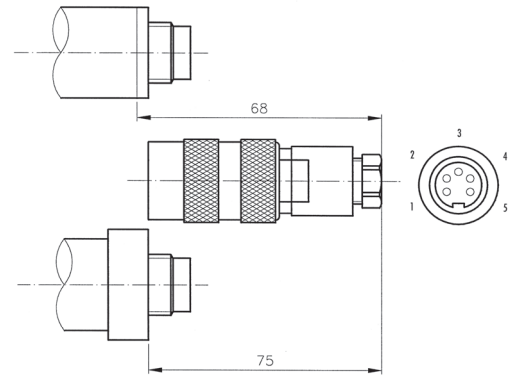

885X.XX.XXXX.14.XX.37

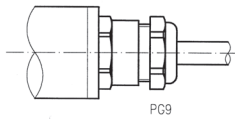

885X.XX.XXXX.22/39.XX.XX

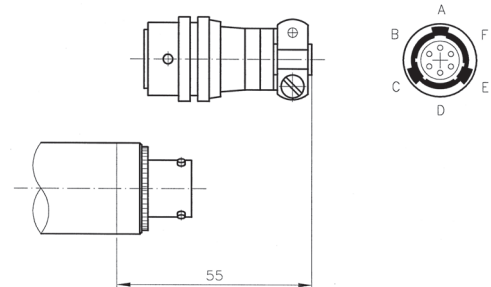

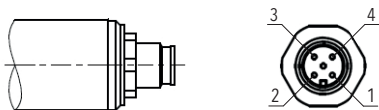

885X.XX.XXXX.02.XX.32

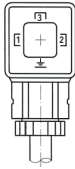
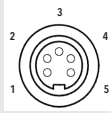

885X.XX.XXXX.32.XX.XX

Elektrischer Anschluss

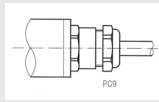
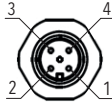
Schutzart IP65					
Ausführung	Industriestandard EN175301-803A	Binder 723	MIL-C 26482	Kabel	M12x1 4-polos
Anschluss	04 	14 	02 	22/39 	32 
4 ... 20 mA					
+ V _{in}	1	3	A	weiss	4
P _{out}	2	1	C	gelb	3
⊖ EP	3	5	F	grau	1
Für Ex-Zonen	1, 2 20, 21, 22	0, 1, 2 20, 21, 22	0, 1, 2 20, 21, 22	0*, 1, 2 20, 21, 22	1, 2 20, 21, 22

* **Achtung!** Für Zone 0 bzw. 20 sind bei diesen Kabeln zusätzliche Massnahmen gegen statische Aufladung notwendig (Verlegung mit geerdetem Metallgeflecht, Metallschlauch oder Metallrohr).

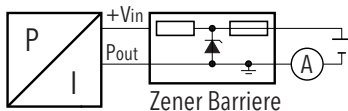

Kennzeichnung	
Für Ex Zonen	Kennzeichnung
0, 1, 2, 20, 21, 22 M1, M2	 II 1G Ex ia IICT3 ... T6 Ga II 1D Ex ia IICT125°C Da I M1 Ex ia I Ma
1, 2 20, 21, 22 M2	 II 2G Ex ia IICT3 ... T6 Gb II 1D Ex ia IICT125°C Da I M2 Ex ia I Mb

Erweiterte Informationen		
Dokumente	Datenblatt	www.trafag.com/H72227
	Betriebsanleitung	www.trafag.com/H73227
	Flyer	www.trafag.com/H70685