

NAH 8254

Pressure Transmitter



Product description

The pressure transmitter NAH 8254 with increased accuracy of 0.3 % and optional switching outputs has an exceptionally long-term stable thin-film-on-steel sensor cell with triple (optionally 5-fold) overpressure protection. The robust design and the wide temperature range of -40°C to +125°C make the NAH 8254 the ideal solution when pressure needs to be measured accurately and reliably under rough environmental conditions.

Technical Data

Measuring principle	Thin-film-on-steel
Measuring range	0 ... 0.2 to 0 ... 1000 bar 0 ... 3 to 0 ... 10000 psi
Output signal	4 ... 20 mA, 0 ... 5 VDC, 1 ... 5 VDC, 1 ... 6 VDC, 0 ... 10 VDC and more, 0.5 ... 4.5 VDC ratiometric, Switching output: 1 or 2 PNP
Media temperature	-40°C ... +125°C
Ambient temperature	max. -40°C ... +125°C (UL-rated Ambient temperature: -20°C ... +80°C) Details see section: Electrical Connection

Additional information

Data sheet	www.trafag.com/H72304
Instructions	www.trafag.com/H73303
Accessories	www.trafag.com/H72258
Video	https://youtu.be/CyN6xyg-A2A

Applications

- Machine tools
- Hydraulics
- Process technology
- Measuring and test bench technology

Features

- Measuring accuracy 0.3 %
- Completely welded steel sensor system without additional seals
- Optional: 5-fold overpressure resistance
- Optional: Switching output 1 or 2 PNP
- Optional: Ex zone 2 conformity

 EMC: 2014/30/EU

 S.I. 2016 No. 1091

 RoHS/Reach compliant

 UL-listed version

Ordering information/Type code

Ordering information/Type code				8254	XX	XX	XX	XX	XX	XX
Measuring range ¹⁾	Pressure measurement range [bar]	Over pressure [bar]	Burst pressure [bar]	Pressure-measurement-range [psi]	Over pressure [psi]	Burst pressure [psi]				
	0 ... 0.2 ²⁾	1.2	25	68	0 ... 3 ²⁾	15	350	F8		
	0 ... 0.4 ²⁾	1.2	25	69	0 ... 5 ²⁾	15	350	F9		
	0 ... 0.6 ²⁾	1.2	25	70	0 ... 10 ²⁾	20	350	G0		
	0 ... 1.0 ²⁾	2	25	71	0 ... 15 ²⁾	30	350	G1		
	0 ... 1.6 ²⁾	3.2	50	73	0 ... 25 ²⁾	50	700	G3		
	0 ... 2.5	7.5	50	75	0 ... 30	90	700	G5		
	0 ... 4	12	60	76	0 ... 50	150	850	G6		
	0 ... 6	18	100	77	0 ... 100	300	1450	G7		
	0 ... 10	30	200	78	0 ... 150	450	2500	G8		
	0 ... 16	48	200	79	0 ... 200	600	2500	GA		
	0 ... 25	75	300	80	0 ... 250	750	2500	G9		
	0 ... 40	120	300	81	0 ... 300	900	4000	HA		
	0 ... 60	180	400	82	0 ... 400	1200	4000	H0		
	0 ... 100	300	500	83	0 ... 500	1500	4000	H1		
	0 ... 160	480	750	85	0 ... 1000	3000	5000	H2		
	0 ... 250	750	1000	74	0 ... 1500	4500	7000	H3		
	0 ... 400	1000	2000	84	0 ... 2000	6000	10000	H5		
	0 ... 600	1500	2500	86	0 ... 3000	9000	14500	G4		
	0 ... 700	1500	2500	87	0 ... 5000	12500	21750	H4		
	0 ... 1000	1500	2500	88	0 ... 7500	18750	29000	H6		
					0 ... 10000	18750	29000	H7		
	Option 5P: Fivefold overpressure				Option: Maximum Overpressure					
	0 ... 2.5	12.5	60	55	0 ... 30	150	1450	E5		
	0 ... 4	20	100	56	0 ... 50	180	1450	E6		
	0 ... 6	30	200	57	0 ... 100	450	3500	E7		
	0 ... 10	50	200	58	0 ... 150	700	4250	E8		
	0 ... 16	80	300	59	0 ... 200	700	4250	EA		
	0 ... 25	125	300	60	0 ... 250	1150	5750	E9		
	0 ... 40	200	400	61	0 ... 300	1150	5750	FA		
	0 ... 60	300	500	62	0 ... 400	1800	8500	F0		
	0 ... 100	500	750	63	0 ... 500	1800	8500	F1		
	0 ... 160	800	1000	65	0 ... 1000	4600	19000	F2		

Sensor

Relative pressure, accuracy: 0.3 %

23

	8254	XX	XX	XX	XX	XX	XX
Pressure connection	G1/4" male, Seal: DIN 3869						17
	G1/4" male, with integrated damping Ø 0.5 mm, Seal: DIN 3869 ³⁾						15
	G1/4" male (Manometer) EN 837						53
	G1/8" male DIN3852-E ⁴⁾						54
	1/4" NPT male						30
	1/8" NPT male ⁵⁾						43
	3/8"-24UNF-2A male, SAE J1926-2 (Heavy Duty) ⁶⁾						68
	7/16"-20UNF female, SAE J512 with valve opener ⁷⁾						24
	7/16"-20UNF female, SAE J512 without valve opener ⁷⁾						44
	7/16"-20UNF male, DIN3866 ⁷⁾						18
	7/16"-20UNF-2A male, SAE J1926-2 (Heavy Duty) ⁶⁾						69
	9/16"-18UNF-2A male, SAE J1926-2 (Heavy Duty) ⁶⁾						67
	R1/4" male, DIN3858						19
	R1/4" male, DIN2999 ⁸⁾						20
	R1/8" male, DIN3858 ⁴⁾						16
	M10x1 male, DIN EN ISO 6149-2 ⁹⁾						32
	M10x1 male, ISO 9974-2 ⁴⁾						70
	M12x1 male, DIN EN ISO 6149-2 ¹⁰⁾						64
	M12x1.25 male, DIN EN ISO 6149-2 ¹⁰⁾						65
	M12x1.5 male, DIN EN ISO 9974-2						49
M14x1.5 male DIN EN ISO 6149-2 ⁸⁾						31	
Electrical connection	Male electrical connector, industrial standard, contact distance 9.4 mm, Mat. PA, EN 175301-803C						01
	Male electrical connector M12x1, 4-pole, Mat. PA, IEC 61076-2-101						32
	Male electrical connector M12x1, 5-pole, Mat. PA, IEC 61076-2-101						35
	Male electrical connector MIL-C 26482, 6-pole, metal						02
	Male electrical connector Deutsch DT04-3P, 3-pole						D3
	Male electrical connector Deutsch DT04-4P, 4-pole						D4
	3 Way M Delphi MetriPack 1.5 sealed connector, Mat. PA66 ¹¹⁾						51
	Cable Mat. PVC, IP67/IP68, 2 x 2 x 0.14 mm ² , max. traction on cable: 2 N ¹²⁾						22
	Cable Mat. PUR, IP67/IP68, 4 x 0.25 mm ² , shielded ¹²⁾						24
	Cable Mat. EPD Raychem FDR25, IP67, 4 x 0.2 mm ² , shielded ¹²⁾						08
	Cable Mat. Radox Tenuis, IP67/IP68, 4 x 0.5 mm ² , shielded ¹²⁾						88
	Compact design: Cable Mat. PVC, IP40, 2 x 2 x 0.14 mm ² , shielded, max. traction on cable: 2 N ⁸⁾¹³⁾						A1
	JST (or compatible) Board to Cable/Wire Disconnectable Crimp style connector, BM04B-SRSS-TB, IP20, 4-pole ⁸⁾						J4

		8254	XX	XX	XX	XX	XX	XX
Output signal	Output signal	Load resistance	I (supply)	U (supply)				
	4 ... 20 mA	See graphic	(= signal output)	24 (9 ... 32) VDC				19
	0.5 ... 4.5 VDC	$\geq 5.0 \text{ k}\Omega$ to U_s -	$\leq 20 \text{ mA}$	24 (9 ... 32) VDC				20
	0 ... 5 VDC	$\geq 5.0 \text{ k}\Omega$ to U_s -	$\leq 20 \text{ mA}$	24 (9 ... 32) VDC				14
	0.1 ... 4.1 VDC	$\geq 5.0 \text{ k}\Omega$ to U_s -	$\leq 20 \text{ mA}$	24 (9 ... 32) VDC				28
	0.1 ... 5.1 VDC	$\geq 5.0 \text{ k}\Omega$ to U_s -	$\leq 20 \text{ mA}$	24 (9 ... 32) VDC				29
	0.5 ... 5 VDC	$\geq 5.0 \text{ k}\Omega$ to U_s -	$\leq 20 \text{ mA}$	24 (9 ... 32) VDC				22
	1 ... 5 VDC	$\geq 5.0 \text{ k}\Omega$ to U_s -	$\leq 20 \text{ mA}$	24 (9 ... 32) VDC				25
	0.5 ... 5.5 VDC	$\geq 5.0 \text{ k}\Omega$ to U_s -	$\leq 20 \text{ mA}$	24 (9 ... 32) VDC				24
	1 ... 6 VDC	$\geq 5.0 \text{ k}\Omega$ to U_s -	$\leq 20 \text{ mA}$	24 (9 ... 32) VDC				16
	0 ... 10 VDC	$\geq 5.0 \text{ k}\Omega$ to U_s -	$\leq 15 \text{ mA}$	24 (15 ... 32) VDC				17
	1 ... 10 VDC	$\geq 5.0 \text{ k}\Omega$ to U_s -	$\leq 15 \text{ mA}$	24 (15 ... 32) VDC				26
	0.1 ... 10.1 VDC	$\geq 5.0 \text{ k}\Omega$ to U_s -	$\leq 15 \text{ mA}$	24 (15 ... 32) VDC				13
	0.5 ... 4.5 VDC ratiom.	$\geq 5.0 \text{ k}\Omega$ to U_s -	$\leq 10 \text{ mA}$	5 (4.75 ... 5.25) VDC				23
	2 PNP Transistoren ¹⁴⁾		$\leq 10 \text{ mA}$	24 (9 ... 32) VDC				PS
1 PNP Transistor ¹⁵⁾		$\leq 10 \text{ mA}$	24 (9 ... 32) VDC				T1	
Accessories	Female electrical plug M12x1, 5-pole ¹⁶⁾							33
	Female electrical plug industrial standard (for electrical connection 01), EN 175301-803C							34
	Female electrical plug M12x1, 5-pole, metallic housing ¹⁶⁾							35
	Pressure peak damping element \varnothing 1.0 mm							40
	Pressure peak damping element \varnothing 0.4 mm							44
	Seal FKM, -18°C ... +125°C							61
	Seal EPDM, -40°C ... +125°C							63
	Seal NBR, -25°C ... +100°C							83
	Cable length 0.5 m							EM
	Cable length 1.0 m							1M
	Cable length 2.0 m							2M
	Parameterization standard for output signal PS, T1 (see table: Parameters)							ZS
	Parameterization according to customer specification for output signal PS, T1 (see table: Parameters)							ZC
	Multiple packaging ¹⁷⁾							VM
	UL-listed, see table: Possible combinations for UL-listed variants							UL
	Ex Zone conformity according EN 60079-0, EN 60079-7, see table: EX Zone 2-Possible combinations and requirements ^{18) 19)}							EX
	Enhanced condensation protection							CP
	Signal processing, cut-off frequency, see table: Signal processing							
Pin configuration, see table: Electrical connection								

Footnotes: See next page

Ordering information/Type code

- ⁰¹⁾ Customized pressure ranges, upon request
- ⁰²⁾ Only for pressure connections 17, 30, 32, 54, 68, 70 and with output signals 4 ... 20 mA Code 19, and ratiometric. output signals 0.5 ... 4.5 VDC Code 23
- ⁰³⁾ For measuring ranges ≥ 2.5 bar
- ⁰⁴⁾ max. allowable pressure range 160 bar (2320 psi) at 480 bar (6961 psi) overpressure
- ⁰⁵⁾ max. allowable pressure range 400 bar (5800 psi) at 600 bar (8700 psi) overpressure
- ⁰⁶⁾ Measuring range max. 630 bar according to SAE J1926-2 (Heavy Duty)
- ⁰⁷⁾ max. allowable pressure range 60 bar (870 psi) at 180 bar (2610 psi) overpressure
- ⁰⁸⁾ Upon request, whereas minimum order quantities may apply
- ⁰⁹⁾ max. allowable pressure range 250 bar (3626 psi) at 750 bar (10878 psi) overpressure
- ¹⁰⁾ Without seal, use seal geometry according DIN EN ISO 6149-2
- ¹¹⁾ Not available with switching output signals (codes PS / T1)
- ¹²⁾ Cable length, see Accessories
- ¹³⁾ Cable length 2m only, with accessory 2M
- ¹⁴⁾ Only with electrical connections 32, 22, 24, 08, 88
- ¹⁵⁾ Only with electrical connections 32, 22, 24, 08, 88, D3
- ¹⁶⁾ For electrical connections 32 and 35
- ¹⁷⁾ The order quantity must be a multiple of 50, only for electrical connections 01, 32, 35, 02, D3, D4, not for pressure connection 30 with electrical connections 02, D3, D4
- ¹⁸⁾ Accessory options UL, EX are mutually exclusive
- ¹⁹⁾ Customer-specific label not allowed

Compatibility matrix pressure connection and accessories

Code	Pressure connection	Damping		Seal		
		Ø 1.0 mm (Code 40)	Ø 0.4 mm (Code 44)	FKM (Code 61)	EPDM (Code 63)	NBR (Code 83)
17	G1/4" male, Seal: DIN 3869	✓	✓	✓	✓	✓
15	G1/4" male, with integrated damping Ø 0.5 mm, Seal: DIN 3869			✓	✓	✓
53	G1/4" male (Manometer) EN 837					
54	G1/8" male DIN 3852-E	✓	✓	✓	✓	
30	1/4" NPT male	✓	✓			
43	1/8" NPT male	✓	✓			
68	3/8"-24UNF-2A male, SAE J1926-2 (Heavy Duty)	✓	✓	✓	✓	
24	7/16"-20UNF female, SAE J512 with valve opener					
44	7/16"-20UNF female, SAE J512 without valve opener					
18	7/16"-20UNF male, DIN 3866					
69	7/16"-20UNF-2A male, SAE J1926-2 (Heavy Duty)	✓	✓	✓	✓	
67	9/16"-18UNF-2A male, SAE J1926-2 (Heavy Duty)	✓	✓	✓	✓	
19	R1/4" male, DIN 3858	✓	✓			
20	R1/4" male, DIN 2999	✓	✓			
16	R1/8" male, DIN 3858	✓	✓			
32	M10x1 male, DIN EN ISO 6149-2	✓	✓	✓		
70	M10x1 male, ISO 9974-2	✓	✓	✓		
64	M12x1 male, DIN EN ISO 6149-2	✓	✓			
65	M12x1.25 male, DIN EN ISO 6149-2	✓	✓			
49	M12x1.5 male, DIN EN ISO 9974-2	✓	✓	✓		
31	M14x1.5 male DIN EN ISO 6149-2	✓	✓	✓		

Ordering information: Possible type code combinations for UL-listed versions

	Combination with UL
Measuring range	All ranges on datasheet
Sensor	All codes on datasheet
Pressure connection	All codes on datasheet
Electrical connection	All codes on datasheet
Output signal	All codes on datasheet
Accessories	All codes except GA, GS and GU

Signal processing

Code	Cut-off frequency f_G	Rise time (10 ... 90 % nominal pressure)	Output signal			
			4 ... 20 mA	0.5 ... 4.5 VDC ratiometric	0 ... 6 VDC	0 ... 10 VDC
GA ¹⁾	11 Hz	32 ms	x	x	-	-
GS ^{1) 2)}	14 kHz	29 μ s	x	-	-	-
GU ^{1) 2)}	20 kHz	18 μ s	-	x	-	-
Standard specification	350 Hz	1 ms	x	x	x	x

¹⁾ Upon request, whereas minimum order quantities may apply

²⁾ Only with electrical connections 32, 35 with shielded cable and 22, 24, 08, 88, only for pressure ranges ≥ 2 bar

Ex Zone 2 – Possible combinations and requirements

Conformity	EN 60079-0, EN 60079-7
Classification	II 3 G Ex ec IICT5 Gc -25°C \leq Ta \leq 85°C
Electrical connections	Codes 32 and 35 (M12x1, 4-pole and 5-pole)
Electrical outputs	Codes 19, 17 ¹⁾ , 26 ¹⁾ and 13 ¹⁾
Mandatory mating connector	Mating connector with metallic housing (accessory 35 fulfils the criteria)
Included accessory	Enhanced condensation protection (CP)

¹⁾ In combination with EX: on request

Standard configurations

Product No.	Type Code	Pressure range [bar]	Overpressure max. [bar]	Supply [VDC]	Accuracy @ 25°C typ. [%]
NAH0.2A	8254 68 2317 32 0000 0000 19 33 44 61	0 ... 0.2	1.2	9 ... 32	± 0.8
NAH0.4A	8254 69 2317 32 0000 0000 19 33 44 61	0 ... 0.4	1.2	9 ... 32	± 0.8
NAH0.6A	8254 70 2317 32 0000 0000 19 33 44 61	0 ... 0.6	1.2	9 ... 32	± 0.8
NAH1.0A	8254 71 2317 32 0000 0000 19 33 44 61	0 ... 1.0	2	9 ... 32	± 0.6
NAH1.6A	8254 73 2317 32 0000 0000 19 33 44 61	0 ... 1.6	3.2	9 ... 32	± 0.6
NAH2.5A	8254 75 2317 32 0000 0000 19 33 44 61	0 ... 2.5	7.5	9 ... 32	± 0.3
NAH4.0A	8254 76 2317 32 0000 0000 19 33 44 61	0 ... 4	12	9 ... 32	± 0.3
NAH6.0A	8254 77 2317 32 0000 0000 19 33 44 61	0 ... 6	18	9 ... 32	± 0.3
NAH10.0A	8254 78 2317 32 0000 0000 19 33 44 61	0 ... 10	30	9 ... 32	± 0.3
NAH16.0A	8254 79 2317 32 0000 0000 19 33 44 61	0 ... 16	48	9 ... 32	± 0.3
NAH25.0A	8254 80 2317 32 0000 0000 19 33 44 61	0 ... 25	75	9 ... 32	± 0.3
NAH40.0A	8254 81 2317 32 0000 0000 19 33 44 61	0 ... 40	120	9 ... 32	± 0.3
NAH100.0A	8254 83 2317 32 0000 0000 19 33 44 61	0 ... 100	300	9 ... 32	± 0.3
NAH250.0A	8254 74 2317 32 0000 0000 19 33 44 61	0 ... 250	750	9 ... 32	± 0.3
NAH400.0A	8254 84 2317 32 0000 0000 19 33 44 61	0 ... 400	1000	9 ... 32	± 0.3
NAH600.0A	8254 86 2317 32 0000 0000 19 33 44 61	0 ... 600	1500	9 ... 32	± 0.3

Parameters of switching output

Name	Standard setting (accessory ZS)	Value range	Short name	Customer adjustment (accessory ZC)
Switch point SP1 (hysteresis mode) Upper switch point FH1 (window mode)	75 % Measuring range	> RP1, FL1 (2 ... 99 %) Hysteresis \geq 1 % FS	SP1	
Reset point RP1 (hysteresis mode) Lower switch point FL1 (window mode)	25 % Measuring range	< SP1, FH1 (1 ... 98 %) Hysteresis \geq 1 % FS	RP1	
Switch point SP2 (hysteresis mode) Upper switch point FH2 (window mode)	75 % Measuring range	> RP2, FL2 (2 ... 99 %) Hysteresis \geq 1 % FS	SP2	
Reset point RP2 (hysteresis mode) Lower switch point FL2 (window mode)	25 % Measuring range	< SP2, FH2 (1 ... 98 %) Hysteresis \geq 1 % FS	RP2	
Switch point delay time SP1 / RP1 (hysteresis mode) Switch point delay time FH1 / FL1 (window mode)	0	0; approx. 2 ^x [ms], x = 3, 4 ... 16	dS1	
Switch point delay time SP2 / RP2 (hysteresis mode) Switch point delay time FH2 / FL2 (window mode)	0	0; approx. 2 ^x [ms], x = 3, 4 ... 16	dS2	
Functions switching output 1	Hysteresis, closer (Hno)	Hysteresis NO (Hno) Hysteresis NC (Hnc) Window NO (Fno) Window NC (Fnc)	ou1	
Functions switching output 2	Hysteresis, closer (Hno)	Hysteresis NO (Hno) Hysteresis NC (Hnc) Window NO (Fno) Window NC (Fnc) Device ready	ou2	

Specifications

Electrical data	Output / supply voltage	4 ... 20 mA: 24 (9 ... 32) VDC 0 ... 6 VDC ranges: 24 (9 ... 32) VDC 0 ... 10.1 VDC ranges: 24 (15 ... 32) 0.5 ... 4.5 VDC ratiometric: 10 ... 90 % U_s : 5 ± 0.25 VDC 1 or 2 PNP transistors: 24 (9 ... 32) VDC
	Rise time of supply voltage	> 32 V/s
	Power-on delay time pressure transmitters	100 ms
	Power-on delay time pressure switches	50 ms + switching delay time
	Inverse-polarity protection, short-circuit strength @ 25°C during 5 min.	4 ... 20 mA: to $U_s = 32$ VDC 0 ... 6 VDC ranges 0 ... 10.1 VDC ranges: to $U_s = 28$ VDC 0.5 ... 4.5 VDC ratiometric: to $U_s = 14$ VDC 1 or 2 PNP transistors: to $U_s = 32$ VDC
	Resistance of insulation	> 10 M Ω , 50 VDC
	Dielectric strength	50 VAC, 50 Hz
	Current limiting output signal	4 ... 20 mA: 24 mA (Overload)
Environmental conditions	Media temperature	-40°C ... +125°C
	Ambient temperature	max. -40°C ... +125°C (UL-rated Ambient temperature: -20°C ... +80°C) Details see section: Electrical Connection
	Storage temperature	-20°C ... +40°C
	Protection	IP20, IP40, IP65, IP67, IP68 Details see section Electrical Connection
	Humidity	max. 95 % relative
	Vibration	15 g RMS (20 ... 2000 Hz) (EN 60068-2-64) 25 g sin (80 ... 2000 Hz), 1 oct./min, (1x @ 25°C) (EN 60068-2-6)
	Shock	50 g/11 ms 100 g/6 ms Male electrical plug M12x1 (EN 60068-2-27) ²⁾
	EMC protection ¹	Emission
Immunity		EN/IEC 61000-6-2
Mechanical data	Sensor (wetted parts)	1.4542 (AISI 630)
	Pressure connection (wetted parts)	1.4542 (AISI 630)
	Housing	1.4301 (AISI 304)
	Sealing	FKM, EPDM, NBR
	Male electrical connector	See ordering information
	Weight	~ 50 g
	Mounting torque	25 Nm

¹⁾ Electrical connection J4 not EMC tested

²⁾ For electrical connections 32 and 35

Analogue output

			$\geq 0.2 \text{ bar}$ $\leq 0.6 \text{ bar}$	$> 0.6 \text{ bar}$ $< 2.0 \text{ bar}$	$\geq 2.0 \text{ bar}$
Accuracy	TEB @ -25 ... +85°C	[% FS typ.]	± 2.0	± 1.5	± 1.0
	Accuracy @ +25°C	[% FS typ.]	± 0.8	± 0.6	± 0.3
	NLH @ +25°C (BSL)	[% FS typ.]	± 0.2	± 0.2	± 0.2
	TC zero point and span	[% FS/K typ.]	± 0.02	± 0.02	± 0.01
	Long term stability 1 year @ +25°C	[% FS typ.]	± 0.3	± 0.2	± 0.1
	Mounting dependency with 180° rotation (vibration and shock)	[% FS max.]	0.5 mbar	0.5 mbar	0.5 mbar
Rise time	Typ. 1 ms / 10 ... 90 % nominal pressure				

Switchpoint accuracy

Accuracy	TEB @ -25 ... +85°C	[% FS typ.]	± 1.0
	Accuracy @ +25°C	[% FS typ.]	± 0.3
	Long term stability 1 year @ +25°C	[% FS typ.]	± 0.1
Setting range of switchpoints	1 ... 99 % FS		
Distance switch point	≥ 1.0 % FS		
Switch point > reset point	Switchpoint > reset point		
Switching resistance	$\leq 3 \Omega$		
Output function	Hysteresis, Window; normally closed (NO), normally open (NC)		
Switching current	-40°C ... +85°C	(Ambient and media temperature)	$\leq 400 \text{ mA}$, total of both switching outputs
	+85°C ... +125°C	(Ambient and media temperature)	$\leq 200 \text{ mA}$, total of both switching outputs
Current limiting	Integrated		
Lifetime	$> 100 \times 10^6$ cycles		
Delay time	0; approx. 2^x [ms], $x = 3, 4 \dots 16$		
Switching frequency	max. 60 Hz (at switching delay time = 0)		

Measuring accuracy

$\geq 0.2 \text{ bar} \dots \leq 0.6 \text{ bar}$

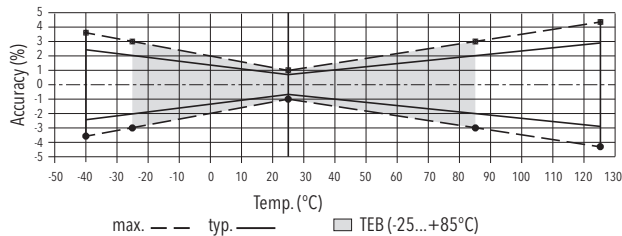

$> 0.6 \text{ bar} \dots < 2.0 \text{ bar}$

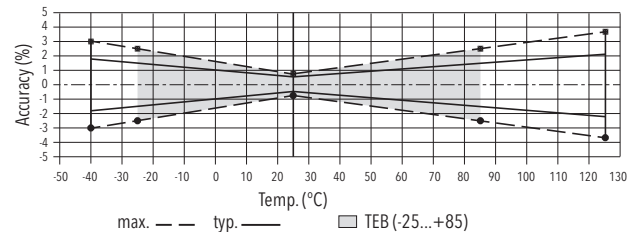

$\geq 2.0 \text{ bar}$

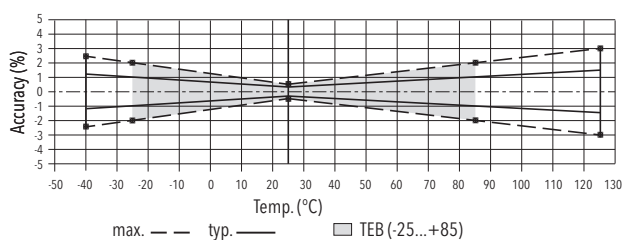

NAH 8254

Dimensions

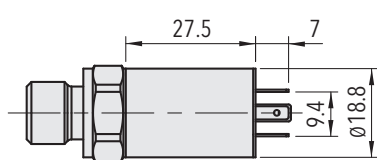

8254.XX.XXXX.01.XX.XX

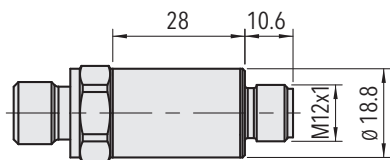

8254.XX.XXXX.32/35.XX.XX

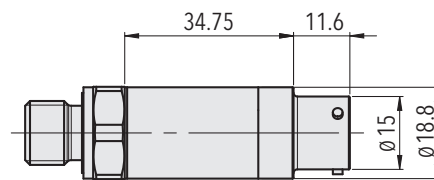

8254.XX.XXXX.02.XX.XX

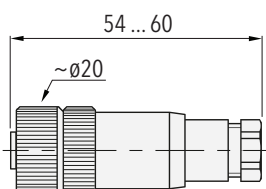

8254.XX.XXXX.XX.XX.33

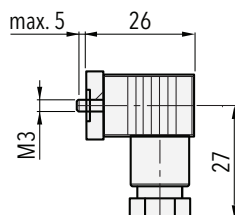

8254.XX.XXXX.XX.XX.34

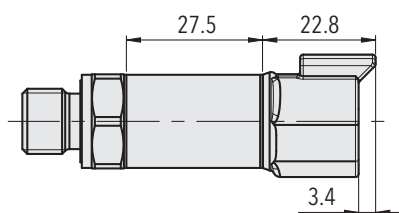

8254.XX.XXXX.D3.XX.XX

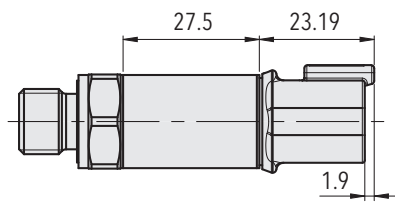

8254.XX.XXXX.D4.XX.XX

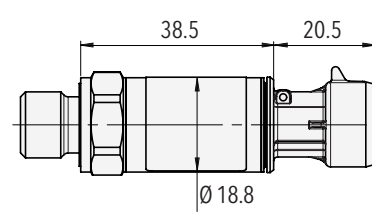

8254.XX.XXXX.51.XX.XX

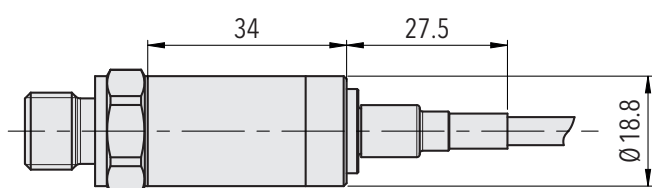

8254.XX.XXXX.08.XX.XX

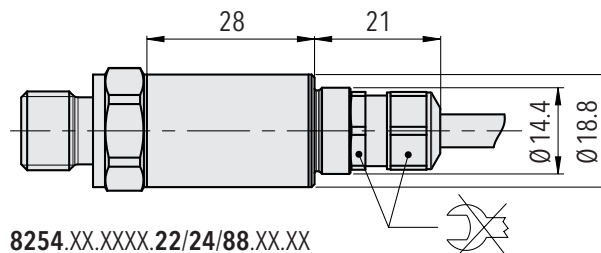

8254.XX.XXXX.22/24/88.XX.XX

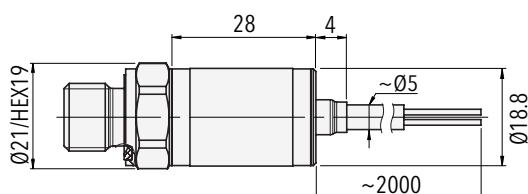

8254.XX.XXXX.A1.XX.XX

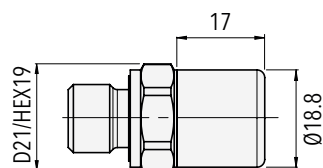

8254.XX.XXXX.J4.XX.XX

NAH 8254

Dimensions

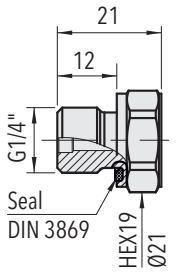

8254.XX.XX17.XX.XX.XX

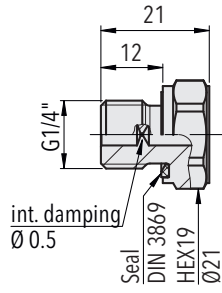

8254.XX.XX15.XX.XX.XX

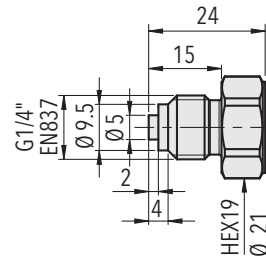

8254.XX.XX53.XX.XX.XX

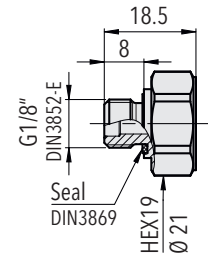

8254.XX.XX54.XX.XX.XX

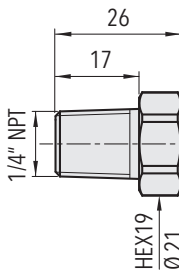

8254.XX.XX30.XX.XX.XX

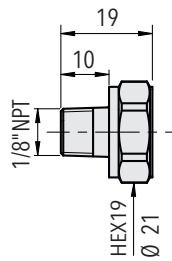

8254.XX.XX43.XX.XX.XX

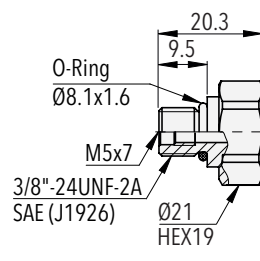

8254.XX.XX68.XX.XX.XX

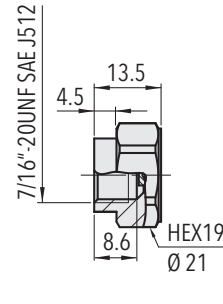

8254.XX.XX24.XX.XX.XX

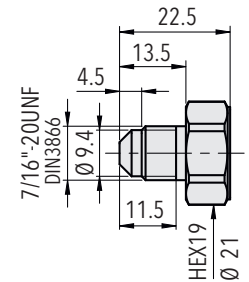

8254.XX.XX18.XX.XX.XX

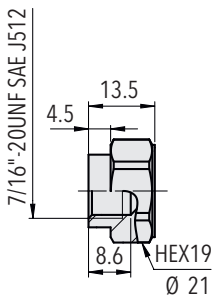

8254.XX.XX44.XX.XX.XX

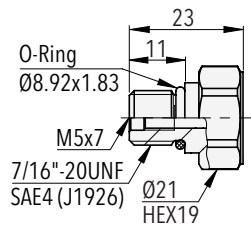

8254.XX.XX69.XX.XX.XX

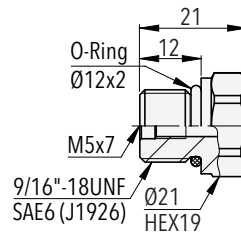

8254.XX.XX67.XX.XX.XX

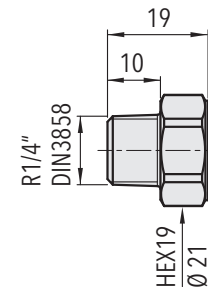

8254.XX.XX19.XX.XX.XX

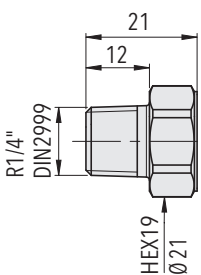

8254.XX.XX20.XX.XX.XX

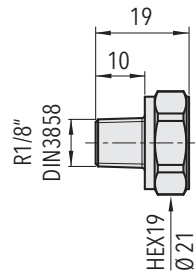

8254.XX.XX16.XX.XX.XX

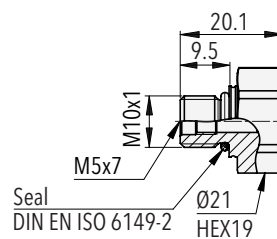

8254.XX.XX32.XX.XX.XX

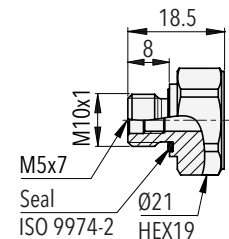

8254.XX.XXXX.70.XX.XX.XX

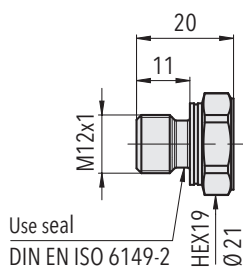

8254.XX.XX64.XX.XX.XX

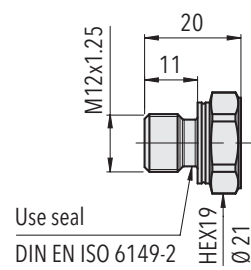

8254.XX.XX65.XX.XX.XX

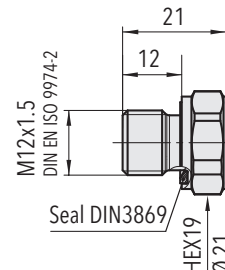

8254.XX.XX49.XX.XX.XX

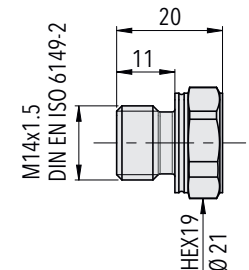

8254.XX.XX31.XX.XX.XX

Electrical connection

	DT04-3P, 3-pole	DT04-4P, 4-pole	3 Way M MetriPack 1.5 sealed connector	Cable	Cable			
Electrical connection type code	D3	D4	51	22	24			
IP protection	IP67, IP68 ^{1) 4)}	IP67, IP68 ^{1) 4)}	IP67 ¹⁾	IP67, IP68 ^{2) 3)}	IP67, IP68 ^{2) 3)}			
Ambient temperature	-40°C ... +125°C	-40°C ... +125°C	-40°C ... +125°C	-30°C ... +80°C	-40°C ... +70°C			
UL-rated ambient temperature	-20°C ... +80°C	-20°C ... +80°C	-20°C ... +80°C	-20°C ... +80°C	-20°C ... +70°C			
Pin assignment type code		F0	G3	E4				
Output signal 8254.xx.xxxx.xx.19 	A B	A C	2 1 3	2 3 1	1 2 3	White Brown Yellow	White Brown Yellow	
Pin assignment type code		F1	G4	99				
Output signal 8254.xx.xxxx.xx.13/14/16/17/20/22/23/24/25/26/28/29 	A C B	A B C	2 4 1 3	2 1 3	1 3 2	1 2 3	White Green Brown Yellow	White Green Brown Yellow

¹⁾ Provided female electrical plug is mounted according to instructions



²⁾ Ventilation via male electric plug/cable end

³⁾ IP68, 20 bar, 30 min.

⁴⁾ IP68, 100 mbar, 4h

i Empty 'Pin Assignment Type Code' field: Default pinout

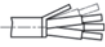
Electrical connection

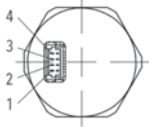
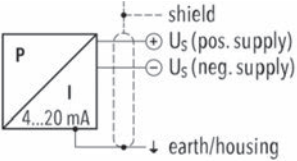
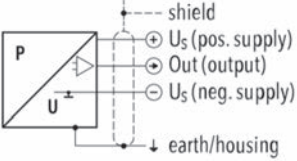
	Cable	Cable	Cable	JST SH Series
				
Electrical connection type code	08	88	A1	J4
IP protection	IP67 ²⁾	IP67, IP68 ^{2) 3)}	IP40	IP20
Ambient temperature	-40°C ... +125°C	-40°C ... +100°C	-30°C ... +80°C	-40°C ... +125°C
UL-rated ambient temperature	-20°C ... +80°C	-20°C ... +80°C	-20°C ... +80°C	-20°C ... +80°C
Pin assignment type code				
Output signal 8254.xx.xxxx.xx.19 	Red Black Green	Brown Black Yellow/Green	Brown White Yellow	1 2 4
Pin assignment type code				
Output signal 8254.xx.xxxx.xx.13/14/16/17/20/22/23/24/25/26/28/29 	Red White Black Green	Brown Blue Black Yellow/Green	Brown Green White Yellow	1 3 2 4

²⁾ Ventilation via male electric plug/cable end

³⁾ IP68, 20 bar, 30 min.

i Empty 'Pin Assignment Type Code' field: Default pinout

Electrical connection

	M12x1, 4-pole		Cable		Cable	
Electrical connection type code	32		22		24	
IP protection	IP67 ^{1) 2)}		IP67, IP68 ^{2) 3)}		IP67, IP68 ^{2) 3)}	
Ambient temperature	-40°C ... +125°C		-30°C ... +80°C		-40°C ... +70°C	
UL-rated ambient temperature	-20°C ... +80°C		-20°C ... +80°C		-20°C ... +70°C	
Pin assignment type code	PS	T1	PS	T1	PS	T1
Output signal 8254.xx.xxxx.xx.PS/T1						
	1 4 2 3	1 4 - 3	White Green Yellow Brown	White Green - Brown	White Green Yellow Brown	White Green - Brown
	Cable		Cable		DT04-3P, 3-pole	
Electrical connection type code	08		88		D3	
IP protection	IP67 ²⁾		IP67, IP68 ^{2) 3)}		IP67, IP68 ^{1) 4)}	
Ambient temperature	-40°C ... +125°C		-40°C ... +100°C		-40°C ... +125°C	
UL-rated ambient temperature	-20°C ... +80°C		-20°C ... +80°C		-20°C ... +80°C	
Pin assignment type code	PS	T1	PS	T1	T1	
Output signal 8254.xx.xxxx.xx.PS/T1						
	Red White Green Black	Red White - Black	Brown Blue Yellow/Green Black	Brown Blue - Black	A - C - B	

¹⁾ Provided female electrical plug is mounted according to instructions

²⁾ Ventilation via male electric plug/cable end

³⁾ IP68, 20 bar, 30 min.

⁴⁾ IP68, 100 mbar, 4h

4...20mA: min./max resistor vs. supply voltage @ Pmax = 100%

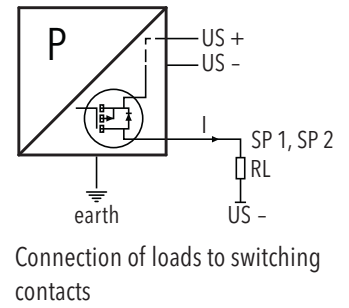
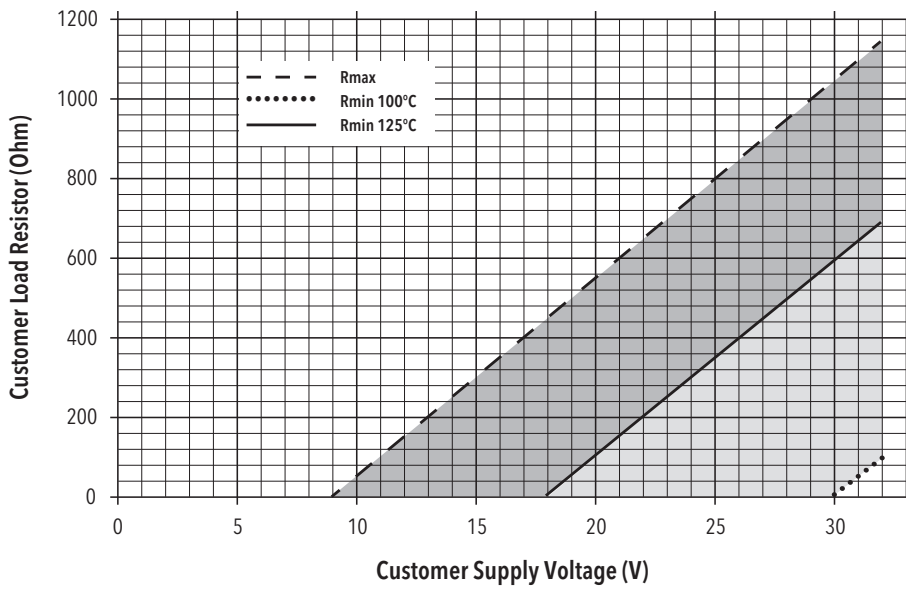

Functional diagram

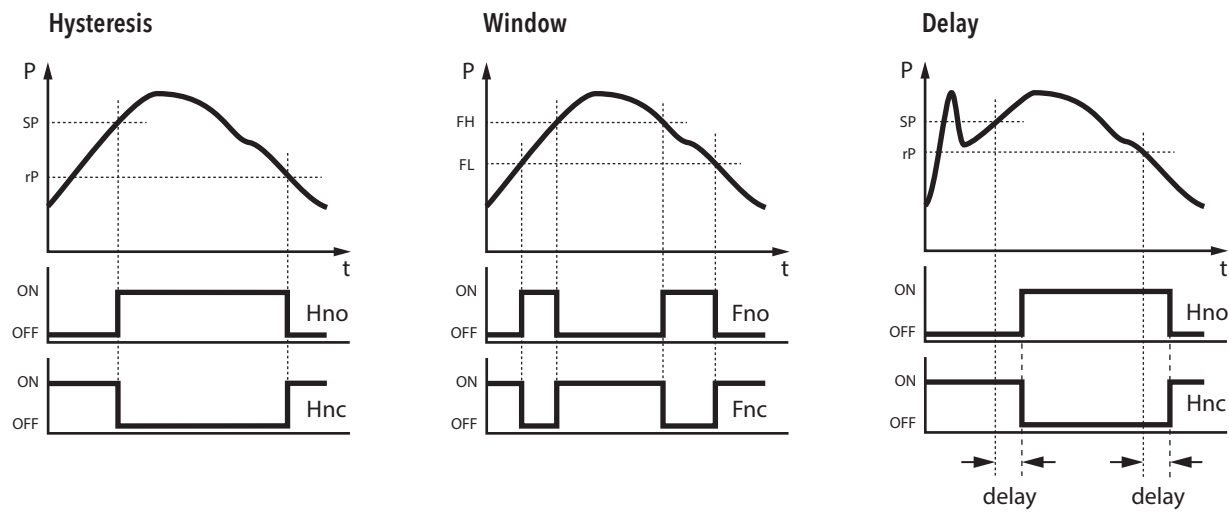

Reliable quality

Worldwide represented, globally trusted, Swiss based

Trafag develops, produces and distributes robust, reliable and precise instruments for monitoring pressure, temperature and gas density.

The broad portfolio of pressure and temperature measuring instruments is tailored for use in test benches through to applications in harsh environments. The research and development departments in Switzerland and Germany develop all important components from the sensor to the application-specific microchip, which are

then manufactured in the production facilities in Switzerland, Germany, the Czech Republic, and India. Strict quality management according to ISO 9001 and ISO 14001 ensures that Trafag products meet the required quality and sustainability standards.

Trafag is headquartered in Switzerland, was founded in 1942 and has an extensive sales and service network in more than 40 countries worldwide.

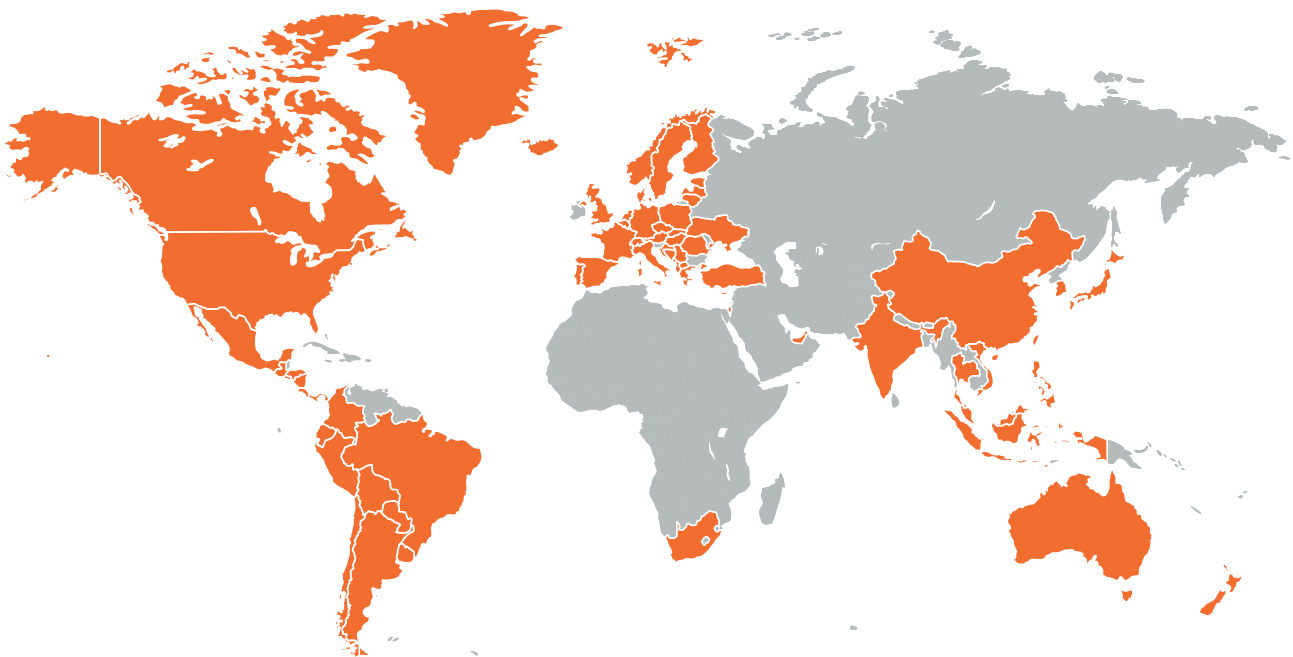

Headquarters Switzerland

Trafag AG
Industriestrasse 11
8608 Bubikon (Switzerland)
+41 44 922 32 32
trafag@trafag.com
www.trafag.com

Coordinates of representatives can be found at www.trafag.com/trafag-worldwide



Pressure transmitters



Electronic pressure switches



Mechanical pressure switches



Pressure gauge



Thermostats



Temperature transmitters



Gas density