

RAILWAY PRESSURE TRANSMITTER

Swiss based Trafag is a leading international supplier of high quality sensors and monitoring instruments for measurement of pressure and temperature. The EPR pressure transmitter was specifically designed for the high demand of the railway industry and offers reliable and accurate pressure measurement over a wide temperature range. Its excellent long-term stability is based on the leading thin-film-on-steel sensor technology from Trafag.



Applications

- Railways



Features

- Dielectrical strength: 500 VAC, 50 Hz, meets EN50155 (Railways)
- Compact design
- Good temperature resistance
- Different accuracy classes
- Completely welded steel sensor system without additional seals

Technical Data

Measuring principle	Thin-film-on-steel	Accuracy @ 25°C typ.	± 0.5 % FS typ. ± 0.3 % FS typ.
Measuring range	0 ... 2.5 to 0 ... 600 bar	Media temperature	-40°C ... +125°C
Output signal	4 ... 20 mA	Ambient temperature	-40°C ... +125°C
NLH @ 25°C (BSL) typ.	± 0.2 % FS typ. ± 0.1 % FS typ.	Approval / conformity	EN 50155 (Railways)

09/2019

Data sheet H72311g

Subject to change

Ordering information/type code

				8293 . XX	XX	XX	XX	XX	XX
Measuring range ¹⁾	Pressure measurement range [bar]	Over pressure [bar]	Burst pressure [bar]						
	0 ... 2.5	5	100	75					
	0 ... 4	8	100	76					
	0 ... 6	12	100	77					
	0 ... 10	20	200	78					
	0 ... 16	32	200	79					
	0 ... 25	50	300	80					
	0 ... 40	80	300	81					
	0 ... 60	120	500	82					
	0 ... 100	200	500	83					
	0 ... 160	320	1000	85					
	0 ... 250	500	1000	74					
	0 ... 400	800	1500	84					
	0 ... 600	1000	2000	86					
Sensor	Relative pressure, accuracy: 0.3 %			23					
	Relative pressure, accuracy: 0.5 %			25					
Pressure connection	G1/4" male (Seal)				17				
	R1/4" male ²⁾				19				
	1/4" NPT male ³⁾				30				
	1/2" NPT male ³⁾				51				
Electrical connection	Male electrical connector EN 175301-803-A (DIN43650-A), Mat. PA						04		
	Male electrical connector EN 175301-803-A, Mat. PA, Extended vibration resistance						05		
	Male electrical connector MIL-C 26482, 6-pole, metal ⁴⁾						02		
Output signal	Signal output	Load resistance	I (supply)	U (supply)					
	4... 20 mA	(U _{supply} -9 V) / 20 mA		9 ... 32 VDC				19	
Accessories	Pressure peak damping element ø 1.0 mm								40
	Pressure peak damping element ø 0.3 mm								43
	Pressure peak damping element ø 0.5 mm								45
	Female electrical plug EN 175301-803-A (DIN43650-A)/NBR, -40°C ... +90°C, for cable diameter 4 ... 9 mm, flammability standard UL94-V0								46
	Female electrical plug EN 175301-803-A (DIN43650-A)/Silicone, -40°C ... +125°C, for cable diameter 4 ... 9 mm, flammability standard UL94-V0								56
	Female electrical plug EN 175301-803-A (DIN43650-A)/NBR, -40°C ... +90°C, for cable diameter 4 ... 9.5 mm, flammability standard UL94-V2								58
	Female electrical plug MIL-C 26482, 6-pole, metal								32
	Special electrical connection: Pin 1 +, Pin 2 - (only for output signal 4 ... 20 mA and male electrical connector EN175301-803-A / DIN43650-A)								92

¹⁾ Extended overpressure as well as customized pressure ranges upon request

²⁾ Only with electrical connection 04

³⁾ Upon request

⁴⁾ For pressure ranges < 40 bar upon request

Specifications		
Electrical Data	Dielectric strength	500 VAC, 50 Hz
	Resistance of insulation	> 10 MΩ, 500 VDC
	Output / supply voltage	4...20 mA: 24 (9...32) VDC
	Rise time	Typ. 1 ms/10...90 % nominal pressure
Environmental conditions	Media temperature	-40°C ... +125°C
	Ambient temperature	-40°C ... +125°C
	Protection ¹⁾	IP65, IP67
	Humidity	Max. 95 % relative
	Vibration	Electrical connection 04/02: 10g (20...2000 Hz)/5 grms Electrical connection 05: 15g (20...2000 Hz)
	Shock	50 g / 11 ms
EMC Protection	Emission	EN/IEC 61000-6-4
	Immunity	EN/IEC 61000-6-2
Mechanical Data	Sensor (wetted parts)	1.4542 (AISI630)
	Pressure connection (wetted parts)	Pressure ranges ≤ 250 bar and > 600 bar: 1.4542 (AISI630) Pressure ranges > 250 bar and ≤ 600 bar: 1.4301 (AISI304)
	Housing	1.4301 (AISI304) except male electrical plug 04 and 2.5...250bar: 1.4542 (AISI630)
	Sealing	FKM 70 Sh
	Male electrical plug	See ordering information
	Weight	~ 80...110 g
	Mounting torque	25 Nm

¹⁾ See electrical connection

Accuracy			
		Measuring accuracy 0.5%	Measuring accuracy 0.3%
		Ordering No. 25	Ordering No. 23
TEB @ -25...+85°C	[% FS typ.]	± 2.0	± 0.5
Accuracy @ +25°C	[% FS typ.]	± 0.5	± 0.3
NLH @ +25°C (BSL)	[% FS typ.]	± 0.2	± 0.1
TC zero point and span	[% FS/K typ.]	± 0.03	± 0.005
Long term stability 1 year @ +25°C	[% FS typ.]	± 0.2	± 0.2

Measuring accuracy 0.5 %

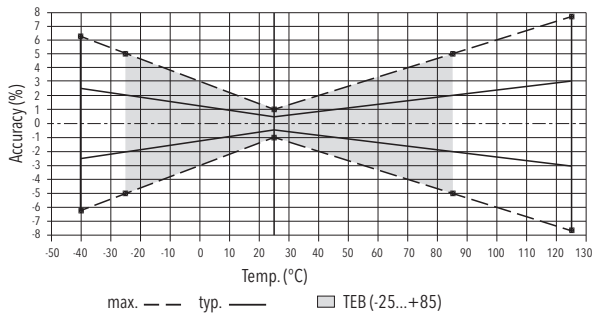

Measuring accuracy 0.3 %

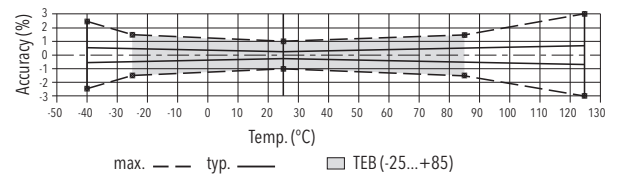

Dimensions

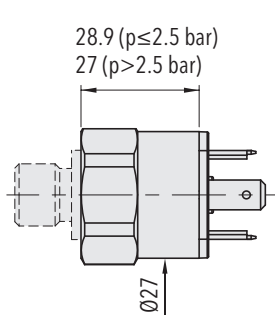

8293.XX.XXXX.04.XX.XX

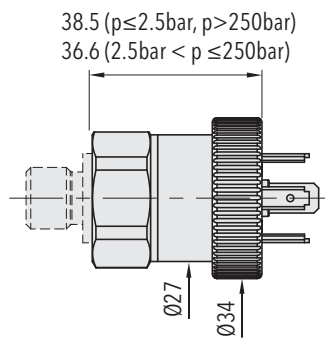

8293.XX.XXXX.05.XX.XX

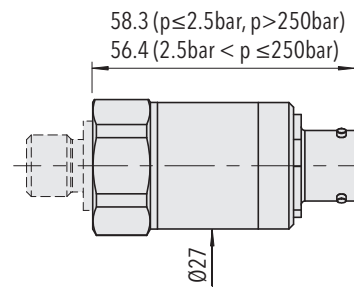

8293.XX.XXXX.02.XX.XX

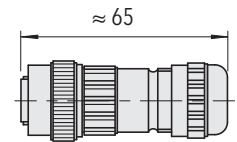

8293.XX.XXXX.02.XX.32

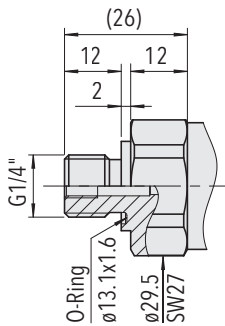

8293.XX.XX17.XX.XX

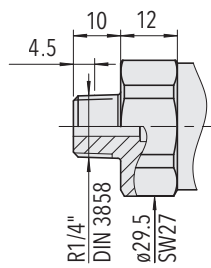

8293.XX.XX19.XX.XX

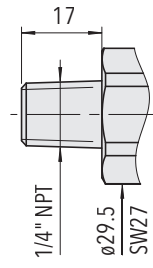

8293.XX.XX30.XX.XX

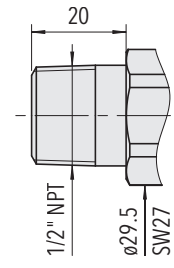

8293.XX.XX51.XX.XX

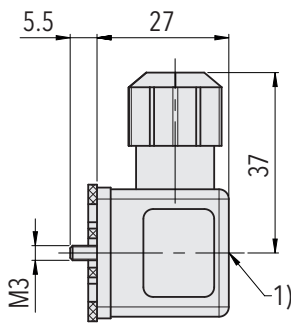

1) Tightening torque 50...60 Ncm

8293.XX.XXXX.XX.XX.46/56

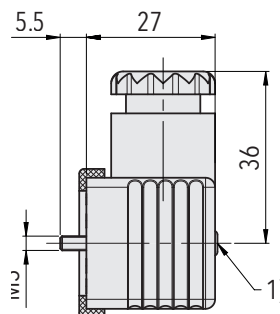

1) Tightening torque 50...60 Ncm

8293.XX.XXXX.XX.XX.58

Electrical connection

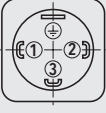
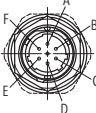
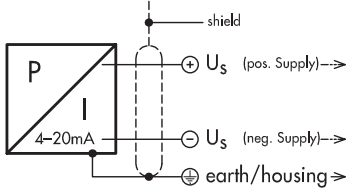
		Protection / electrical connection		
		IP65	IP67*	
		Industrial standard EN175301-803A 04/05 	MIL-C 26482 02 	
Output signal		Standard	with accessory 92	
	8293.XX.XXXX.XX.19	2 1 ⊕	1 2 ⊕	A B E

*1) Provided female connector is mounted according to instructions

Additional information

Documents

Data sheet	www.trafag.com/H72311
Instructions	www.trafag.com/H73311
Flyer	www.trafag.com/H70674