

# DISPLAY PRESSURE SWITCH

Swiss based Trafag is a leading international supplier of high quality sensors and monitoring instruments for measurement of pressure and temperature. The DPS 8381 is the ideal combination of pressure switch and transmitter with a pressure display. The parameters are set on the device or in a timesaving way via an NFC - smartphone App. The settings in combination with a comprehensive set of options make the DPS 8381 suitable for a wide range of demanding applications.

## Applications

- Machine tools
- Hydraulics
- Process technology
- Industrial applications



## Features

- Parameterization also via NFC-smartphone App (Android)
- Display and electrical connection are independently rotatable 335°/343°
- Analogue output switchable mA or V
- Integrated datalogger
- Measuring range adjustable

04/2020

Data sheet H72321k

Technical Data			
Measuring principle	Thin-film-on-steel	Accuracy @ 25°C typ.	± 0.5 % FS typ.
Measuring range	0 ... 2.5 to 0 ... 600 bar 0 ... 30 to 0 ... 7500 psi adjustable	Media temperature	-25°C ... +85°C
Output signal	4 ... 20 mA, 0 ... 5 VDC, 1 ... 6 VDC, 0 ... 10 VDC, switchable mA or V	Ambient temperature	-25°C ... +85°C
NLH @ 25°C (BSL) typ.	± 0.2 % FS typ.	Pressure unit for display	bar, psi, MPa, kPa, mWC, mmWC, inchWC, %, user scale
Switching output	2 transistors PNP	Logger	Ring buffer: 3518 data points Sampling time: 0.1 ... 999.9 s, Off (0)

Subject to change

## Ordering information/type code

				8381 . XX			XX	XX	XX	XX	XX
Measuring range <sup>1)</sup>	Pressure measurement range [bar]	Over pressure [bar]	Burst pressure [bar]	Pressure measurement range [psi]	Over pressure [psi]	Burst pressure [psi]					
		0 ... 2.5	7.5	50	75	0 ... 30	90	700	G5		
	0 ... 4	12	60	76	0 ... 50	150	850	G6			
	0 ... 6	18	100	77	0 ... 100	300	1450	G7			
	0 ... 10	30	200	78	0 ... 150	450	2500	G8			
	0 ... 16	48	200	79	0 ... 200	600	2500	GA			
	0 ... 25	75	300	80	0 ... 250	750	2500	G9			
	0 ... 40	120	300	81	0 ... 300	900	4000	HA			
	0 ... 60	180	400	82	0 ... 400	1200	4000	H0			
	0 ... 100	300	500	83	0 ... 500	1500	4000	H1			
	0 ... 160	480	750	85	0 ... 1000	3000	5000	H2			
	0 ... 250	750	1000	74	0 ... 1500	4500	7000	H3			
	0 ... 400	1000	2000	84	0 ... 2000	6000	10000	H5			
	0 ... 600	1500	2500	86	0 ... 3000	9000	14500	G4			
					0 ... 5000	12500	21750	H4			
					0 ... 7500	18750	29000	H6			
<b>Sensor</b>	Relative pressure, accuracy: 0.5 %										25
<b>Pressure connection</b>	G1/4" female <sup>2)</sup>	10	1/2" NPT male <sup>2)</sup>	51							
	G1/4" male, Seal: DIN 3869 (accessories 61/63/83)	17	R1/4" male, DIN3858 <sup>2)</sup>	19							
	G1/4" male, with integrated damping Ø 0.5 mm, Seal: DIN 3869 (accessories 61/63/83)	15	M14x1.5 male, DIN6149-2 <sup>2)</sup>	31							
	G1/4" male (Manometer) EN 837 <sup>2)</sup>	53	7/16"-20UNF male, DIN3866 <sup>2) 4)</sup>	18							
	G1/2" male (Manometer) EN 837 <sup>2)</sup>	11	7/16"-20UNF male, SAE4 (J1926) <sup>2)</sup>	42							
	1/4" NPT male <sup>2)</sup>	30	7/16"-20UNF female, SAE J512 with valve opener <sup>2) 4)</sup>	24							
				9/16"-18UNF male, SAE6 (J1926), seal: accessory 61 <sup>2)</sup>	61						
<b>Electrical connection</b>	Male electrical connector M12x1, 4-pole, Mat. PA (Accessories P3, P4)										32
	Male electrical connector M12x1, 5-pole, Mat. PA (Accessories P1, P2)										35
<b>Output signal</b>	Switching output PNP, current output 4 ... 20 mA, switchable to 0 ... 10 VDC; output detail see accessories P1, P2, P3										PA
	Switching output PNP, voltage output 1 ... 6 VDC; output detail see accessories P1, P2, P3										PU
	Switching output PNP, voltage output 0 ... 10 VDC; output detail see accessories P1, P2, P3										PV
	Switching output PNP, voltage output 0 ... 5 VDC; output detail see accessories P1, P2, P3										PW
	Switching output PNP; output detail see accessory P4										PS
<b>Accessories</b>	Pin configuration 5-pole.; 1: U+, 2: analogue, 3: U-, 4: SP1, 5: SP2										P1
	Pin configuration 5-pole.; 1: U+, 2: SP2, 3: U-, 4: SP1, 5: analogue										P2
	Pin configuration 4-pole.; 1: U+, 2: analogue, 3: U-, 4: SP1										P3
	Pin configuration 4-pole.; 1: U+, 2: SP2, 3: U-, 4: SP1										P4
	Pressure peak damping element Ø 1.0 mm, material 1.4305 <sup>5)</sup>										40
	Pressure peak damping element Ø 0.4 mm, material 1.4305 <sup>5)</sup>										44
	Seal FPM, -18°C ... +125°C										61
	Seal EPDM, -40°C ... +125°C										63
	Seal NBR, -25°C ... +100°C										83
	Female electrical plug M12x1, 5-pole <sup>3)</sup>										33
	Parameterization standard for output signal PS, T1 (see table "Parameters")										ZS
	Parameterization according to customer specification (see table "Parameters")										ZC
	Function package 1: Zero set / Measuring range zero point adjustment										Z1
	Function package 2: User scale unit / analogue output adjustment										Z2
	Protective cap, 1 pc. F89051, package of 5 pcs. F89052, package of 25 pcs. F89075										
	Adapter with flange connection, 1 pc. F82054										

<sup>1)</sup> Extended overpressure as well as customized pressure ranges upon request

<sup>2)</sup> Upon request

<sup>3)</sup> For electrical connections 32 and 35

<sup>4)</sup> Max. allowable pressure range 60 bar at 120 bar overpressure

<sup>5)</sup> Not for pressure connections 10, 18, 24

## Standard products (extra short lead time)

Product No.	Type Code	Pressure range [bar]	Over pressure max. [bar]	Supply [VDC]	Accuracy @ 25°C typ. [%]
DPS2.5PAP1	8381 75 2517 35 0000 0000 PA P1 44 61 ZS Z1 Z2	0 ... 2.5	7.5	15 ... 30	± 0.5
DPS4.0PAP1	8381 76 2517 35 0000 0000 PA P1 44 61 ZS Z1 Z2	0 ... 4	12	15 ... 30	± 0.5
DPS6.0PAP1	8381 77 2517 35 0000 0000 PA P1 44 61 ZS Z1 Z2	0 ... 6	18	15 ... 30	± 0.5
DPS10.0PAP1	8381 78 2517 35 0000 0000 PA P1 44 61 ZS Z1 Z2	0 ... 10	30	15 ... 30	± 0.5
DPS16.0PAP1	8381 79 2517 35 0000 0000 PA P1 44 61 ZS Z1 Z2	0 ... 16	48	15 ... 30	± 0.5
DPS25.0PAP1	8381 80 2517 35 0000 0000 PA P1 44 61 ZS Z1 Z2	0 ... 25	75	15 ... 30	± 0.5
DPS40.0PAP1	8381 81 2517 35 0000 0000 PA P1 44 61 ZS Z1 Z2	0 ... 40	120	15 ... 30	± 0.5
DPS60.0PAP1	8381 82 2517 35 0000 0000 PA P1 44 61 ZS Z1 Z2	0 ... 60	180	15 ... 30	± 0.5
DPS100.0PAP1	8381 83 2517 35 0000 0000 PA P1 44 61 ZS Z1 Z2	0 ... 100	300	15 ... 30	± 0.5
DPS160.0PAP1	8381 85 2517 35 0000 0000 PA P1 44 61 ZS Z1 Z2	0 ... 160	480	15 ... 30	± 0.5
DPS250.0PAP1	8381 74 2517 35 0000 0000 PA P1 44 61 ZS Z1 Z2	0 ... 250	750	15 ... 30	± 0.5
DPS400.0PAP1	8381 84 2517 35 0000 0000 PA P1 44 61 ZS Z1 Z2	0 ... 400	1000	15 ... 30	± 0.5
DPS600.0PAP1	8381 86 2517 35 0000 0000 PA P1 44 61 ZS Z1 Z2	0 ... 600	1500	15 ... 30	± 0.5

Parameters				
Name	Standard setting (accessory ZS)	Value range	Short name	Customer adjustment (accessory ZC)
Switch point SP1 (hysteresis mode) Upper switch point FH1 (window mode)	75 % Measuring range	SP1 > RP1 FH1 > FL1 Hysteresis ≥ 1 % FS	SP1	
Reset point RP1 (hysteresis mode) Lower switch point FL1 (window mode)	25 % Measuring range	RP1 < SP1 FL1 < FH1 Hysteresis ≥ 1 % FS	RP1	
Switch point SP2 (hysteresis mode) Upper switch point FH2 (window mode)	75 % Measuring range	SP2 > RP2 FH2 > FL2 Hysteresis ≥ 1 % FS	SP2	
Reset point RP2 (hysteresis mode) Lower switch point FL2 (window mode)	25 % Measuring range	RP2 < SP2 FL2 < FH2 Hysteresis ≥ 1 % FS	RP2	
Switch point delay time SP1 (hysteresis mode) Switch point delay time FH1 (window mode)	0	0 ... 99.99 s	dS1	
Switch point delay time RP1 (hysteresis mode) Switch point delay time FL1 (window mode)	0	0 ... 99.99 s	dR1	
Switch point delay time SP2 (hysteresis mode) Switch point delay time FH2 (window mode)	0	0 ... 99.99 s	dS2	
Switch point delay time RP2 (hysteresis mode) Switch point delay time FL2 (window mode)	0	0 ... 99.99 s	dR2	
Functions switching output 1	Hysteresis, closer (Hno)	Hysteresis NO (Hno), Hysteresis NC (Hnc) Window NO (Fno), Window NC (Fnc)	ou1	
Functions switching output 2	Hysteresis, closer (Hno)	Hysteresis NO (Hno), Hysteresis NC (Hnc) Window NO (Fno), Window NC (Fnc)	ou2	
Pressure units	bar	bar, psi, MPa, kPa, mWC, inchWC	uni	
Measuring range adjustment	100 % Nominal pressure	50 ... 100 % Nominal	P_EP	
Damping (analogue output)	0.01 s	0.01 ... 3.00 s (time constant)	dAA	
Display rotation	No	no, yes (180°)	disr	
Display mode	Current pressure value	Pressure value: current, highest, lowest, display off Current value: decimal places selectable (max. 3)	dis	
Display actualisation	2	1, 2, 5, 20 Hz	duPd	

Specifications		
<b>Electrical Data</b>	Output / supply voltage	4 ... 20 mA: 24 (15 ... 30) VDC 0 ... 5 VDC: 24 (15 ... 30) VDC 1 ... 6 VDC: 24 (15 ... 30) VDC 0 ... 10 VDC: 24 (15 ... 30) VDC
	Power-on delay time	Typ. 200 ms
	Inverse-polarity protection, short-circuit strength @ 25°C during 5 min.	integrated
	Current consumption	≤ 30 mA
<b>Environmental conditions</b>	Media temperature	-25°C ... +85°C
	Ambient temperature	-25°C ... +85°C
	Protection <sup>1)</sup>	IP67
	Humidity	Max. 95 % relative
	Vibration	10 g (10 ... 2000 Hz)
	Shock	50 g / 3 ms
<b>EMC Protection</b>	Emission	EN/IEC 61000-6-3
	Immunity	EN/IEC 61000-6-2
<b>Mechanical Data</b>	Sensor (wetted parts)	1.4542 (AISI630)
	Pressure connection (wetted parts)	1.4542 (AISI630)
	Housing	Zinc based die-casting alloy, nickel plated display housing plastic
	Sealing	FPM, NBR, EPDM
	Male electrical connector	See ordering information
	Weight	~ 189 g
	Mounting torque	15 ... 20 Nm
	Housing alignment	Display 335° rotatable, max. 2.5 Nm Electrical connection 343° rotatable, max. 5 Nm

<sup>1)</sup> See electrical connection

## Measuring accuracy 0.5 %

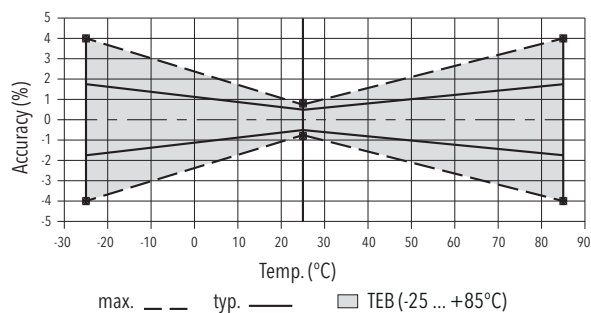

Analogue output			
Output signal	Switchable 4 ... 20 mA or voltage		
Accuracy	TEB @ -25 ... +85°C	[% FS typ.]	± 1.75
	Accuracy @ +25°C	[% FS typ.]	± 0.5
	NLH @ +25°C (BSL)	[% FS typ.]	± 0.2
	TC zero point and span	[% FS/K typ.]	± 0.03
	Long term stability 1 year	[% FS typ.]	± 0.1
Current limiting output signal	4 ... 20 mA: 25 mA (overload)		
	0 ... 10 VDC: < 40 mA (short-circuit)		
Damping (rise time)	0.01 ... 3.00 s / 10 ... 90 % Nominal pressure		
Zero set; <sup>1)</sup>	± 0.2 % FS		
Offset correction of analogue output and display indication			
Measuring range zero point adjustment (P_nP) <sup>1)</sup>	0 ... 50 % FS <sup>2)</sup>		
Measuring range end point adjustment (P_EP)	50 ... 100 % FS <sup>2)</sup>		
Zero point adjustment analogue output (o_nP) <sup>1)</sup>	Voltage output: 0 ... 2 VDC Current output: 3.9 ... o_EP - 8 mA		
End point adjustment analogue output (o_EP) <sup>1)</sup>	Voltage output: o_nP + 4 ... 10.5 VDC Current output: o_nP + 8 ... 20.1 mA		

<sup>1)</sup> Available with optional function package, see "Accessories"

<sup>2)</sup> P\_EP - P\_nP ≥ 50 % FS

Switching output			
Accuracy	Accuracy @ +25°C	[% FS typ.]	± 0.5
	TEB @ -25 ... +85°C	[% FS typ.]	± 1.0
	Long term stability 1 year	[% FS typ.]	≤ ± 0.3
Adjustment range of switchpoints	0 ... 100 % FS		
Switching hysteresis	≥ 1 % FS		
	Switchpoint > reset point		
Switching resistance	≤ 3 Ω		
Output function	Hysteresis, Window; normally closed (NO), normally open (NC)		
Switching current	≤ 0.5 A each switching output		
Current limiting	≤ 2 A each switching output		
Switching frequency	max. 200 Hz		
Delay time	0 ... 99.99 s		

Display	
Display	4-digit 7-segment display 180° flippable with disable function Standard decimal places: ≤ 9: 3 decimal places 10 ... 99: 2 decimal places 100 ... 999: 1 decimal place
Switching status indication	2 LED, red
Operation	With 3 buttons and menu navigation according to VDMA 24574-1
Display resolution	0.1 % FS
Display range	-3 ... 103 % FS
Setting parameters	See table Parameters
User scale unit; User defined values for display indication zero point and end point <sup>1)</sup>	Display zero point: -999 ... 9998 Display end point: -998 ... 9999

<sup>1)</sup> Available with optional function package, see "Accessories"

## Dimensions

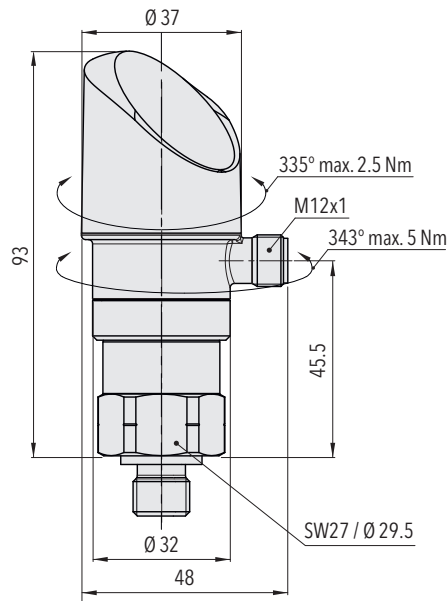

8381.XX.XXXX.35/32.XX.XX

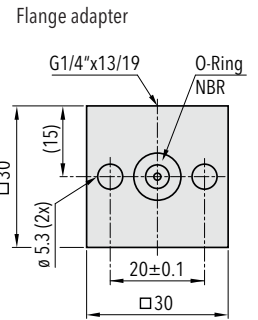
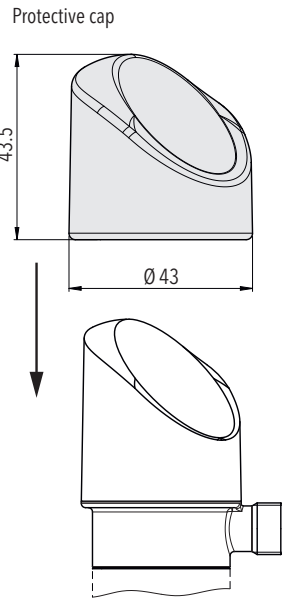

**F82054**  
Mounting accessory included

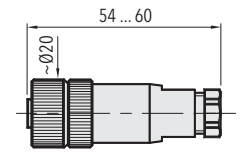

8381.XX.XXXX.XX.XX.33

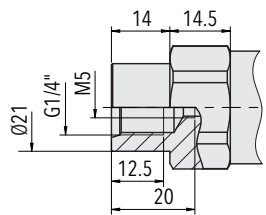

8381.XX.XX10.XX.XX.XX

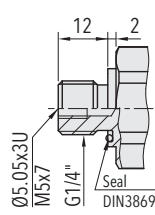

8381.XX.XX17.XX.XX.XX

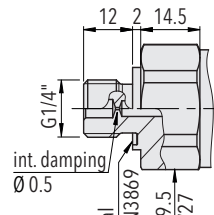

8381.XX.XX15.XX.XX.XX

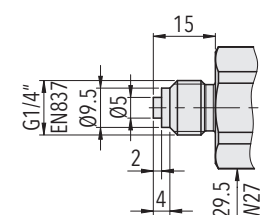

8381.XX.XX53.XX.XX.XX

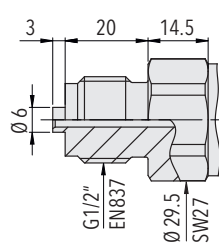

8381.XX.XX11.XX.XX.XX

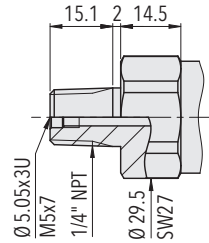

8381.XX.XX30.XX.XX.XX

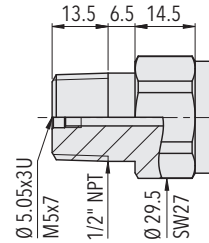

8381.XX.XX51.XX.XX.XX

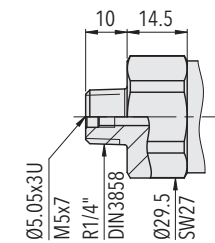

8381.XX.XX19.XX.XX.XX

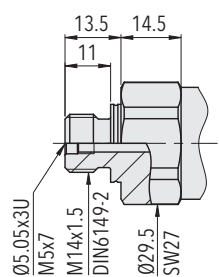

8381.XX.XX31.XX.XX.XX

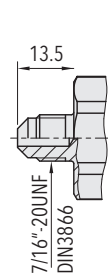

8381.XX.XX18.XX.XX.XX

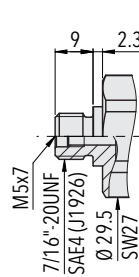

8381.XX.XX42.XX.XX.XX

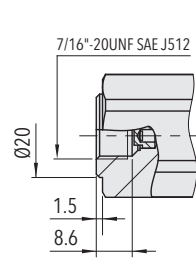

8381.XX.XX24.XX.XX.XX

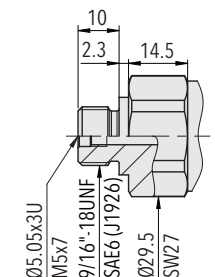

8381.XX.XX61.XX.XX.XX

## Electrical connection

		Protection / electrical connection			
		IP67*)			
		M12x1			
		5-pole <b>35</b>		4-pole <b>32</b>	
Output signal		P1	P2	P3	P4
	PA	✓	✓	✓	
	PU	✓	✓	✓	
	PV	✓	✓	✓	
	PW	✓	✓	✓	
	PS				✓
Pin Configuration		P1	P2	P3	P4
	U <sub>S</sub> + U <sub>S</sub> - Out analogue SP1 SP2 Shield (***)	1 3 2 4 5 Shield (***)	1 3 5 4 2 Shield (***)	1 3 2 4 Shield (***)	1 3 - 4 2 Shield (***)
<b>8381..XX.XXXX.XX.PA/PU/PV/PW/PS</b>					

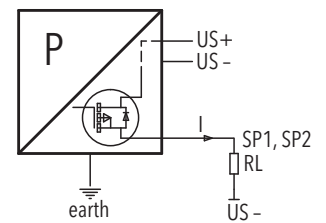

Connection of loads to switching output

\*) Provided female connector is mounted according to instructions

\*\*) The use of a shielded cable is recommended

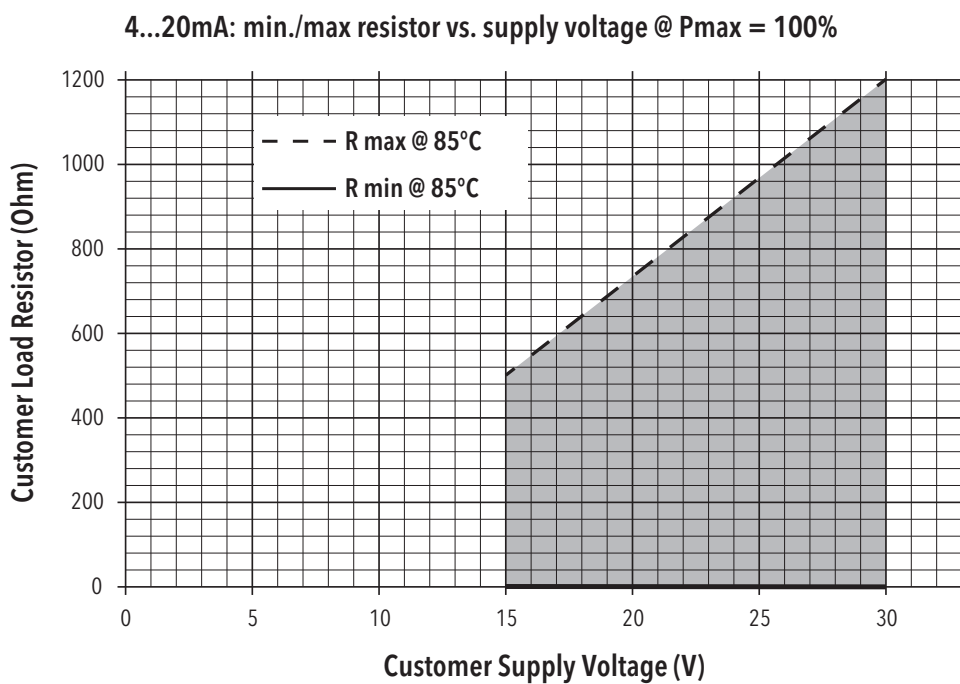



## Functions switching output

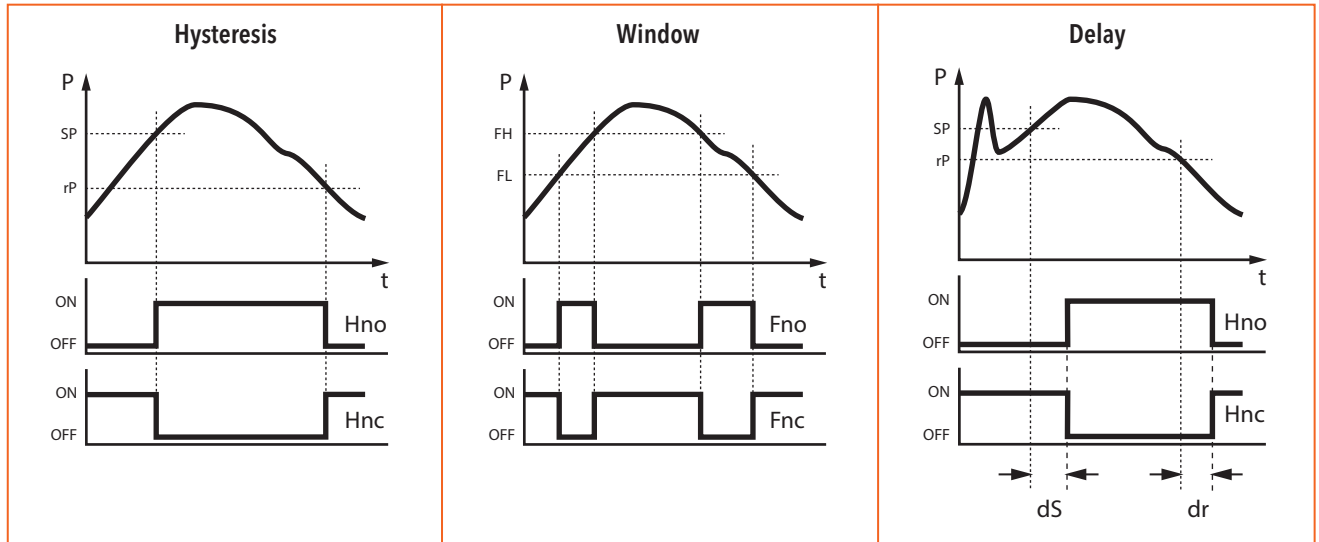

### Additional information

#### Documents

Data sheet	<a href="http://www.trafag.com/H72321">www.trafag.com/H72321</a>
Instructions	<a href="http://www.trafag.com/H73320">www.trafag.com/H73320</a>
Flyer	<a href="http://www.trafag.com/H70694">www.trafag.com/H70694</a>